



# NALS RF

Direct Drive Roof Mounted Single Fans

## Installation and Maintenance

### Introduction

The Nuaire NALS RF Roof Mounted single fan range consists of 3 models in 8 sizes with duties up to 1.40 m<sup>3</sup>/s.

Units are rectangular in section and have 3 different spigot configuration options (see figs 2, 3 and 4) and have a full sized access panel fitted to the top face which is fully detachable for inspection and maintenance purposes.

The units incorporate a motor with a high efficiency, forward curved centrifugal impeller running in metal scrolls. The fan discharges into an outlet chamber through a back-draught shutter system.

The motor is manufactured to BS5000 and is suitable for single phase supply. 'Heatseeker' thermal overload protection is standard as is Class B insulation.

### I.O Handling

Always handle the units carefully to avoid damage and distortion. The units must be lifted by the base only.

Spreaders should be employed and positioned so as to prevent the slings, webbing etc. making contact with the casing.

Correctly position slings to avoid twisting of the unit case and observe the centre of gravity before the final lift is made.

Heavier units will have eyebolts fitted at each lower corner for hoisting. **Note: the weight of the unit from the rating plate.**

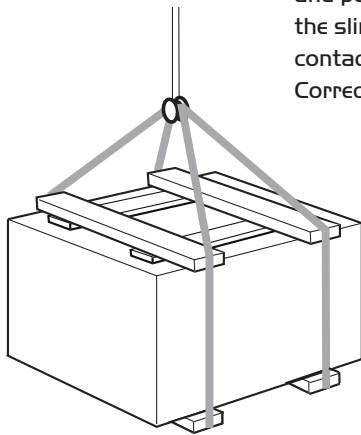

Figure 1. Lifting unit with slings via spreaders.

### 2.0 Installation

The installation must be carried out by competent personnel in accordance with the appropriate authority and conforming to all statutory and governing regulations. NALS RF units are NOT suitable for vertical mounting.

The units may be mounted at and up to a maximum roof angle of 60°. However, the discharge plenum which houses the shutter mechanism must be uppermost and parallel with the roof ridge. (This is to ensure correct shutter operation).

Units are delivered to site ready to be secured to an upstand or curb and connected to a duct and the electrical supply.

### 3.0 Dimensions

Figure 2. \*NALS RF Standard Bottom Inlet.

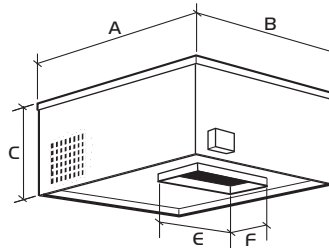

Figure 3. \*NALS RF-S25 Spigot to Spigot.

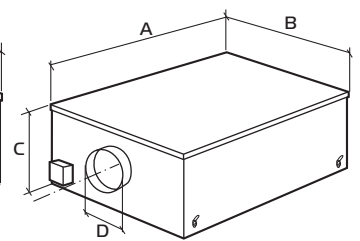
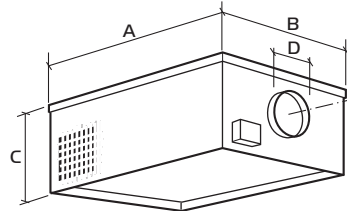

Figure 4. \*NALS RF-B2G Back to Grille.



\*Add model code e.g. - S25

Typical Code	A	B	C	D	E	F	Weight (Kg)
NALS RF1 -*	705	505	355	125	152	76	10.0
NALS RF2 -*	875	720	400	200	229	127	18.0
NALS RF3 -*	970	720	485	200	229	127	23.0
NALS RF4 -*	1165	980	575	250	305	152	31.0
NALS RF5 -*	1165	980	575	250	305	152	31.0
NALS RF6 -*	1165	980	575	400	457	229	57.0
NALS RF7 -*	1165	980	575	400	457	229	57.0
NALS RF8 -*	1495	1125	710	500	762	304	162.0

### 4.0 Mounting

The method of mounting used is the total responsibility of the installer.

The unit must be securely screwed to its curb or upstand to prevent vibration and wind damage. See page 2.

All duct connections must be airtight to prevent any loss of performance.

### 5.0 Ancillaries

A range of stepless speed controls is produced to complement the NALS RF units.

Matching range of silencers is available.

Prefabricated curbs can be supplied for each size of fan unit. See figure 6. page 2.

### 6.0 Ustand Details

Details of roof opening dimensions etc required and basic construction of a builders upstand etc are shown below for typical concrete and decking roof installations.

### Roof Opening Dimensions

Figure 5.

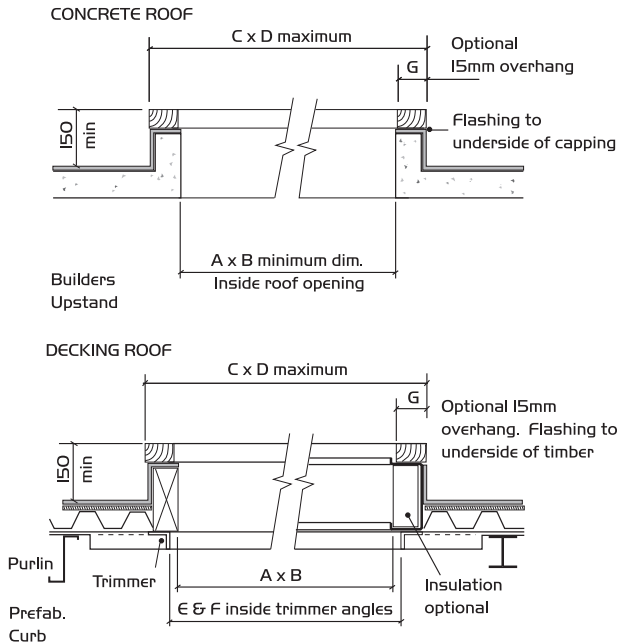

**NB: Wooden capping to be hardwood or treated softwood. Nominally 38mm thick for units size 1 - 5 and 50mm for units 6 - 8.**

Unit Code	A	B	C	D	E	F	G
NALSRF1	535	335	665	465	621	421	50
NALSRF2	700	550	830	680	791	636	50
NALSRF3	795	550	925	680	886	636	50
NALSRF4	940	760	1120	940	1105	920	75
NALSRF5	940	760	1120	940	1105	920	75
NALSRF6	940	760	1120	940	1105	920	75
NALSRF7	940	760	1120	940	1105	920	75
NALSRF8	1265	900	1445	1080	1435	1065	75

### Prefabricated Curb CODES: NALPFC (typical)

Manufactured in aluminium alloy these curbs will reduce design work and guarantee correct unit mounting when on site.

**Note: Upper faces of curb are fitted with robust sealing strip.**

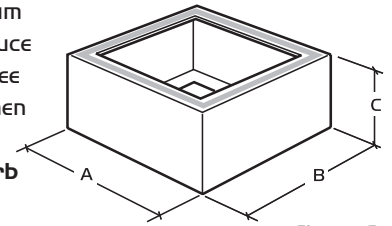

Figure 6.

### Prefabricated curb dimensions

Unit Code	Prefab Curb Code	A	B	C
NALSRF1	NALPFC1	635	435	250
NALSRF2	NALPFC2	805	650	250
NALSRF3	NALPFC3	900	650	250
NALSRF4	NALPFC4	1095	910	250
NALSRF5	NALPFC4	1095	910	250
NALSRF6	NALPFC4	1095	910	250
NALSRF7	NALPFC4	1095	910	250
NALSRF8	NALPFC5	1425	1045	250

### 7.0 Electrical Details

**IMPORTANT**

Isolation - Before commencing work make sure that the unit, and any control are electrically isolated from the mains supply.

Because the run and start currents depend upon the duty and associated duct work of an individual unit, the values quoted in the table are nominal.

Run currents will be exceeded if the unit is operated with its cover removed. It is therefore recommended that the unit is not run for prolonged periods in this condition.

### Motor - Electrical Information

Single Phase (230V) ONLY

Unit Code	Speed rpm	Input power (W)	flc (A)	sc (A)
NALSRF1	2100	81	0.58	1.4
NALSRF2	1260	91	0.54	1.5
NALSRF3	1264	219	1.36	4.6
NALSRF4	1260	328	1.80	5.5
NALSRF5	1260	328	1.80	5.5
NALSRF6	1200	511	2.24	7.9
NALSRF7	1260	915	4	18
NALSRF8	960	1406	6.3	50

### Electrical Wiring

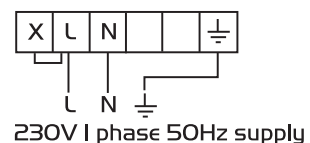

## Speed Control Selection

Unit Code	Speed Control Code	Phase	amp
NALSRF1	ESCI-1.5A	Single	1.5
NALSRF2	ESCI-1.5A	Single	1.5
NALSRF3	ESCI-2.5A	Single	2.5
NALSRF4	ESCI-2.5A	Single	2.5
NALSRF5	ESCI-2.5A	Single	2.5
NALSRF6	ESCI-1.3A	Single	3
NALSRF7	ESCI-1.6A	Single	6
NALSRF8	ESCI-1.10A	Single	10

## 8.0 Maintenance

### IMPORTANT

Isolation - Before commencing work make sure that the unit, and any control are electrically isolated from the mains supply.

### Maintenance Intervals

The first maintenance should be carried out three months after commissioning and thereafter at twelve monthly intervals. These intervals may need to be shortened if the unit is operating in adverse environmental conditions, or in heavily polluted air.

### Lubrication

Motors are fitted with sealed for life bearings and therefore require no further lubrication.

### General Cleaning and Inspection

Clean and inspect the exterior of the twin fan unit and associated controls etc. Remove the access panel from the unit, inspect and if necessary, clean the fan and motor assemblies and the interior of the case.

If the unit is heavily soiled it may be more convenient to remove the fan/motor assemblies.

Check that the shutters are free to move smoothly and that they seal the appropriate fan outlet effectively.

Clean and inspect each fan and motor assembly taking care not to damage, distort or disturb the balance of the impeller.

- a) Lightly brush away dirt and dust, paying particular attention to any build up at the motor ventilating slots. If necessary, carefully remove with a scraper.
- b) Stubborn dirt at the impeller may be carefully removed with a stiff nylon brush.
- c) Check all parts for security and general condition. Check that the impeller rotates freely.

Refit the assemblies to the unit (see replacement parts) then replace the access covers. If speed controls or remote indicators are fitted, remove the covers and carefully clean out the interiors as necessary. Check for damage and security of components. Refit the access covers.

## 9.0 Replacement of Parts

The only item of the fan unit likely to require replacement is the fan/motor assembly due to a failed motor or damaged impeller. In either eventuality the complete fan/motor assembly must be removed from the unit case.

**Note: Before commencing work, electrically isolate the fan unit and/or the associated speed control, if fitted, from the mains supply.**

Remove the access cover. Unplug the motor connection from the underside of the built in control module. Support the weight of the fan/motor assembly and remove the mounting screws and washers. Lift the assembly out of the case.

After replacing the faulty item, refit the fan/motor assembly and reconnected the incoming wiring to the fan mounted connection box. Replace the access cover.

When ordering spares please quote the serial number of the unit which can be found on the identification plate on the side of the unit casing.

## 10.0 Warranty

The unit is guaranteed for 12 months. The warranty starts from the date of delivery and covers faulty materials or workmanship and includes parts and labour. The labour element is subject to full, free and safe access to the equipment as recommended by the CDM regulations.

This warranty is void if the equipment is modified without authorisation, is incorrectly applied, misused, disassembled, or not installed, commissioned and maintained in accordance with the details contained in this manual and general good practice.

The product warranty applies to the UK mainland and in accordance with Clause 14 of our Conditions of Sale. Customers purchasing from outside of the UK should contact Nuair International Sales office for further details.

## 11.0 After Sales Enquiries

For technical assistance or further product information, including spare parts and replacement components, please contact the After Sales Department.

**Telephone 02920 858 400**

## DECLARATION OF INCORPORATION AND INFORMATION FOR SAFE INSTALLATION, OPERATION AND MAINTENANCE

We declare that the machinery named below is intended to be assembled with other components to constitute a system of machinery. The machinery shall not be put into service until the system has been declared to be in conformity with the provisions of the EC Machinery Directive.

**Designation of machinery:** ROOF MOUNTED IN-LINE SINGLE FAN

**Machinery Types:** NALSRF



**Relevant EC Council Directives:** 2006/42/EC (Machinery Directive)

**Applied Harmonised Standards:** BS EN ISO 12100-1, BS EN ISO 12100-2, EN294, EN60204-1, BS EN ISO 9001

**Applied National Standards:** BS848 Parts One, Two and Five

Note: All standards used were current and valid at the date of signature.

**Signature of manufacture representatives:**

Name:	Position:	Date:
1) C. Biggs	 Technical Director	20. 07. 07
2) A. Jones	 Manufacturing Director	20. 07. 07

## INFORMATION FOR SAFE INSTALLATION, OPERATION AND MAINTENANCE OF NUAIRE VENTILATION EQUIPMENT

To comply with EC Council Directives 2006/42/EC Machinery Directive and 2014/30/EU (EMC).

To be read in conjunction with the relevant Product Documentation (see 2.1)

### 1.0 GENERAL

1.1 The equipment referred to in this Declaration of Incorporation is supplied by Nuairé to be assembled into a ventilation system which may or may not include additional components.

The entire system must be considered for safety purposes and it is the responsibility of the installer to ensure that all of the equipment is installed in compliance with the manufacturers recommendations and with due regard to current legislation and codes of practice.

### 2.0 INFORMATION SUPPLIED WITH THE EQUIPMENT

2.1 Each item of equipment is supplied with a set of documentation which provides the information required for the safe installation and maintenance of the equipment. This may be in the form of a Data sheet and/or Installation and Maintenance instruction.

2.2 Each unit has a rating plate attached to its outer casing. The rating plate provides essential data relating to the equipment such as serial number, unit code and electrical data. Any further data that may be required will be found in the documentation. If any item is unclear or more information is required, contact Nuairé.

2.3 Where warning labels or notices are attached to the unit the instructions given must be adhered to.

### 3.0 TRANSPORTATION, HANDLING AND STORAGE

3.1 Care must be taken at all times to prevent damage to the equipment. Note that shock to the unit may result in the balance of the impeller being affected.

3.2 When handling the equipment, care should be taken with corners and edges and that the weight distribution within the unit is considered. Lifting gear such as slings or ropes must be arranged so as not to bear on the casing.

3.3 Equipment stored on site prior to installation should be protected from the weather and steps taken to prevent ingress of contaminants.

### 4.0 OPERATIONAL LIMITS

4.1 It is important that the specified operational limits for the equipment are adhered to e.g. operational air temperature, air borne contaminants and unit orientation.

4.2 Where installation accessories are supplied with the specified equipment eg. wall mounting brackets. They are to be used to support the equipment only. Other system components must have separate provision for support.

4.3 Flanges and connection spigots are provided for the purpose of joining to duct work systems. They must not be used to support the ductwork.

### 5.0 INSTALLATION REQUIREMENTS

In addition to the particular requirements given for the individual product, the following general requirements should be noted.

5.1 Where access to any part of equipment which moves, or can become electrically live are not prevented by the equipment panels or by fixed installation detail (eg ducting), then guarding to the appropriate standard must be fitted.

5.2 The electrical installation of the equipment must comply with the requirements of the relevant local electrical safety regulations.

5.3 For EMC all control and sensor cables should not be placed within 50mm or on the same metal cable tray as 230V switched live, lighting or power cables and any cables not intended for use with this product.

### 6.0 COMMISSIONING REQUIREMENTS

6.1 General pre-commissioning checks relevant to safe operation consist of the following:

Ensure that no foreign bodies are present within the fan or casing.

Check electrical safety. e.g. Insulation and earthing.

Check guarding of system.

Check operation of Isolators/Controls.

Check fastenings for security.

6.2 Other commissioning requirements are given in the relevant product documentation.

### 7.0 OPERATIONAL REQUIREMENTS

7.1 Equipment access panels must be in place at all times during operation of the unit, and must be secured with the original fastenings.

7.2 If failure of the equipment occurs or is suspected then it should be taken out of service until a competent person can effect repair or examination. (Note that certain ranges of equipment are designed to detect and compensate for fan failure).

### 8.0 MAINTENANCE REQUIREMENTS

8.1 Specific maintenance requirements are given in the relevant product documentation.

8.2 It is important that the correct tools are used for the various tasks required.

8.3 If the access panels are to be removed for any reason the electrical supply to the unit must be isolated.

8.4 A minimum period of two minutes should be allowed after electrical disconnection before access panels are removed. This will allow the impeller to come to rest.

**NB: Care should still be taken however since airflow generated at some other point in the system can cause the impeller to "windmill" even when power is not present.**

8.5 Care should be taken when removing and storing access panels in windy conditions.

Technical or commercial considerations may, from time to time, make it necessary to alter the design, performance and dimensions of equipment and the right is reserved to make such changes without prior notice.