



WORLDWIDE VENTILATION SOLUTIONS



NUAIRE. FOR THE COMPLETE VENTILATION SOLUTION



NUAIRE IS A BRITISH COMPANY WITH A LONG HISTORY OF INNOVATION...

...in the field of **ventilation** and air movement **solutions**, and its **products** are known across the world for their superb **quality** and **efficiency**.

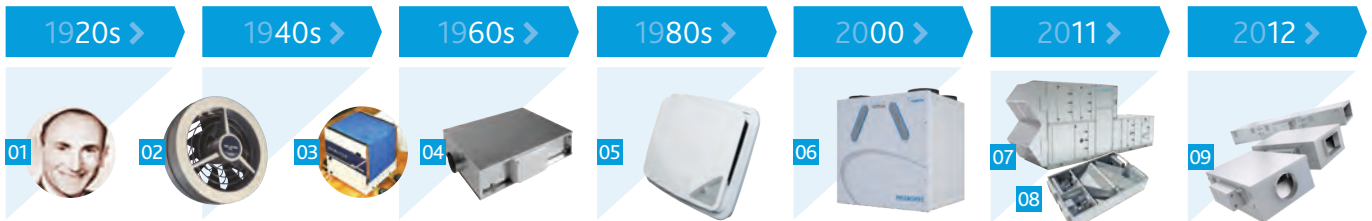

01 NUAIRE ORIGINALLY FOUNDED BY GEORGE AND ALFRED TACK 02 THE NUAIRE 41 FAN 03 ORIGINAL NUAIRE 'DRIMASTER' CONDENSATION UNIT 04 NUAIRE QUIET SCROLL TWIN FANS 05 OPUS FAN 06 MRXBOX95 HEAT RECOVERY 07 BOXER AHU 08 XBOXER XB55 HEAT RECOVERY 09 AIRE-VOLVE TWIN FANS



Founded in 1966, Nuaire has a long and much-admired heritage in developing and manufacturing ventilation products in the UK. The company's expertise is renowned worldwide, likewise their unrivalled customer service, and it is this combination which has ensured that Nuaire's products have been sold into more than 60 countries around the world, including in the Middle East, Europe, the US and Asia.

Nuaire's innovative product development team create multi-award winning ventilation products which are used in a wide range of applications – from food processing plants to oil rigs, shopping malls to hotels – and their systems are installed in some of the world's most iconic buildings, 'such as the [Dubai Mall](#) extension and [Al Khail Mall](#) in the UAE, the [Stade de France sports stadium](#) in Paris and the [Swiss Re bank building](#) – known as 'The Cherkín' – in London.

All Nuaire's products are manufactured in the UK, from their base in South Wales, to exceptionally high standards of quality. Ongoing investment into the manufacturing operation has meant Nuaire can produce state of the art ventilation solutions; in fact, Nuaire was the first fan manufacturer in the world to achieve the **ISO9001** quality standard, and its commitment to quality is enshrined in all aspects of its operations.

Nuaire's commitment to quality excellence extends to all parts of the organisation, including customer service. All 500 staff based in the UK, as well as its dedicated partners around the world, are committed to Nuaire's values of developing the best quality products for our customers and providing superb customer service, ensuring that the organisation is a trusted partner in thousands of construction projects across the globe.

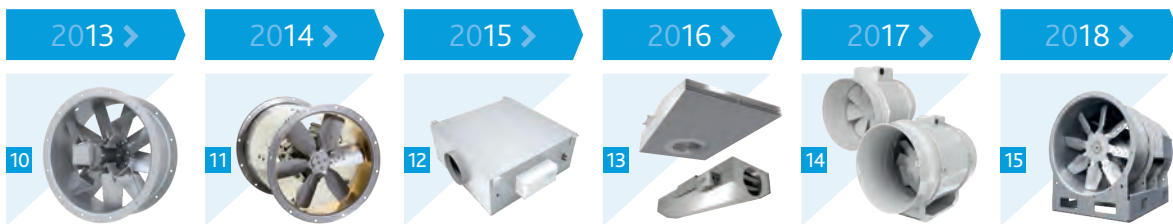

10 ERP AXIAL 11 ATEX AXIAL 12 DAVE 13 F400/2, SVT & SVTC SMOKE FANS 14 ILM/ILM+ 15 HIGH PRESSURE AXIALS



VENTILATION FOR A TYPICAL MULTI-PURPOSE BUILDING

When it comes to ventilation Nuaire offer the complete solution. For any building type, whether it's a hotel, office, hospital or residential development, Nuaire will assess your project in its entirety and recommend ventilation products for every requirement. Simply provide Nuaire's team with your project information and they will ensure that you get the right system for your needs.

TYPICAL PRODUCT RANGES

ROOF AREA

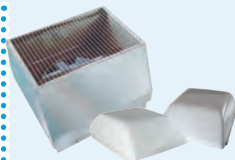

TERMINALS

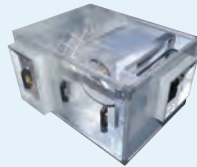

BOXER



HIGH PRESSURE AXIAL



NALSRF

RESTAURANT AREA



AXIAL



SQUIF



BIFURCATED AXIAL



EZ PLATE

OFFICE AREA

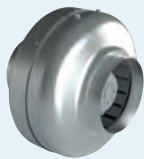

NALT

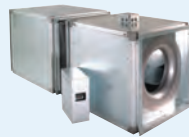

AIRMOVER

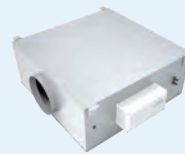

DAVE



AVT

ATRIUM AREA

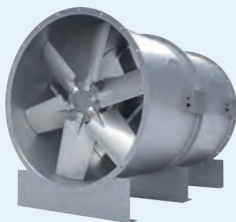

CONTRA ROTATING AXIAL



TWIN SQUIF



SINGLE STAGE AXIAL



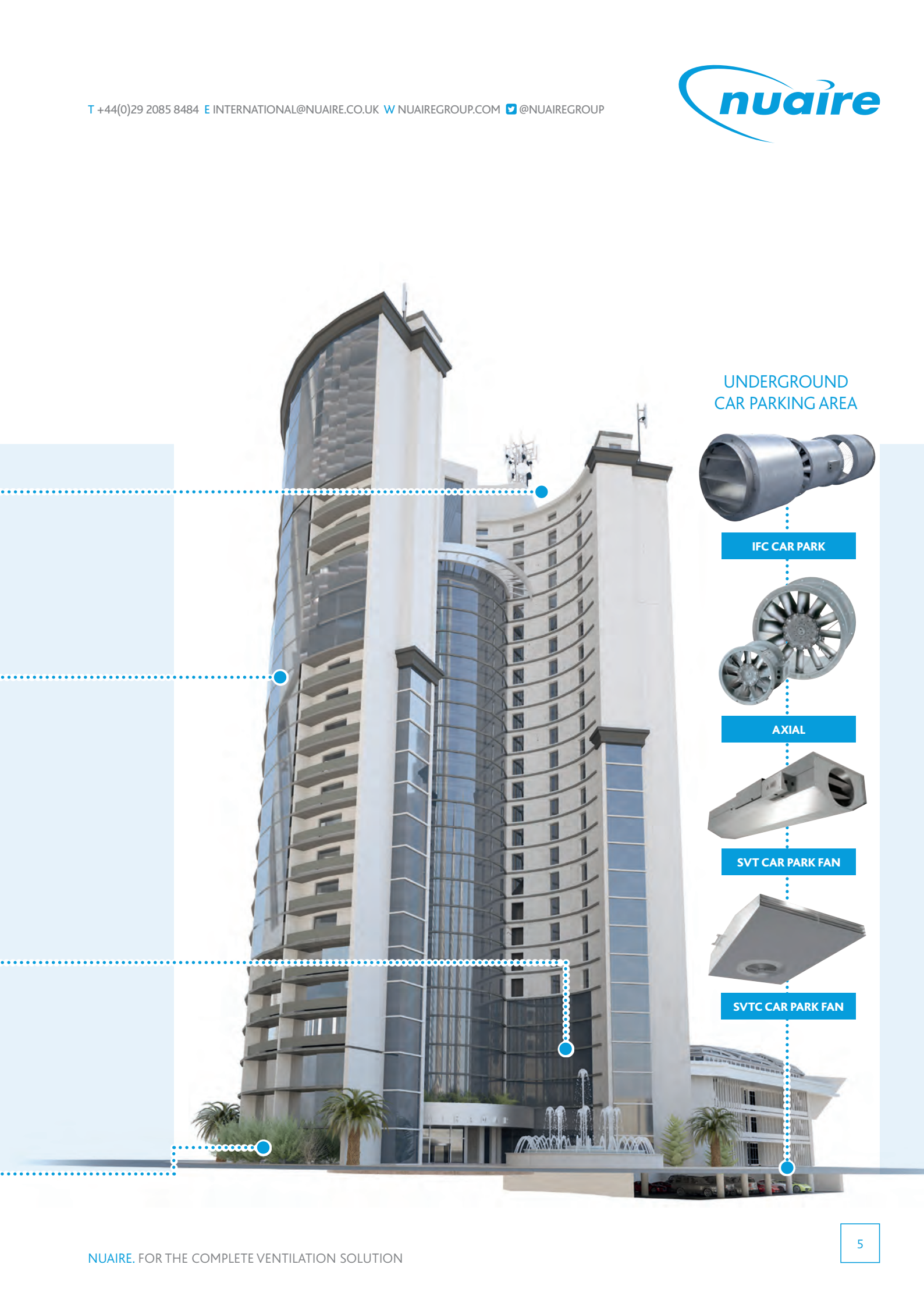

UNDERGROUND
CAR PARKING AREA



IFC CAR PARK



AXIAL



SVT CAR PARK FAN



SVTC CAR PARK FAN



PROJECT REFERENCE LIST

Nuair has worked on hundreds of prestigious projects worldwide, changing the skylines of the future.



SKY VIEW, DUBAI



PEARL QATAR, QATAR



AL HABTOOR CITY RESIDENCE, UAE

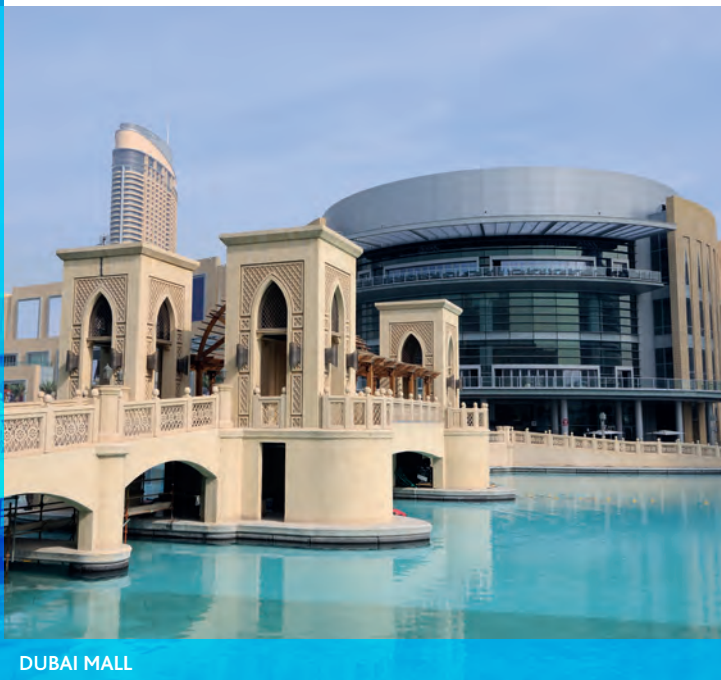

DUBAI MALL



NEW DELHI METRO, INDIA



CHEK LAP AIRPORT, HONG KONG





NATIONAL CONFERENCE CENTRE, QATAR



SIDRA MEDICAL RESEARCH CENTRE, QATAR



KHALIFA STADIUM, QATAR



CENTRAL BANK OF KUWAIT



DOHA FESTIVAL CITY



YAAL MALL

Nuaire's industry-leading ventilation products can be found in some of the most prestigious commercial developments in the world.

Nuaire leads the market in its ability to offer the complete ventilation solution. From schools to luxury hotel resorts to airport developments, underground car parks to penthouse apartments, Nuaire caters to every ventilation requirement from the ground upwards.

Nuaire's comprehensive range of equipment includes industry-leading products to ensure energy-efficient ventilation for every type of building application. Its UK-based manufacturing site and world-class test facilities ensure exceptional product design and quality. Customers around the world can be sure of a tailored service, expert customs knowledge and fast delivery, enabling tight deadlines to be met.



AMCA APPROVED TEST FACILITIES



Nuaire's position at the forefront of the ventilation industry for 50 years has been achieved by constant innovation in product development. This has only been possible due to the company's state of the art in-house test facilities, which have the capability to test for aerodynamic and acoustic performance, and ensure that all products are tested to the latest industry and regional standards for their intended market sector and application.

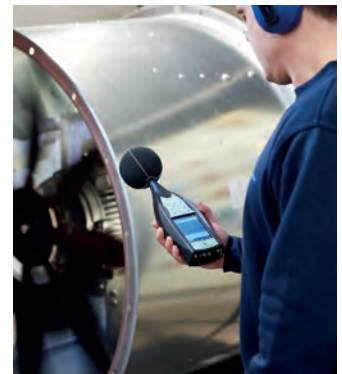
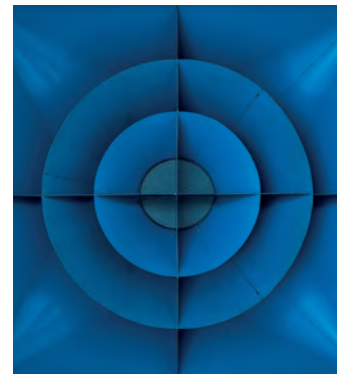
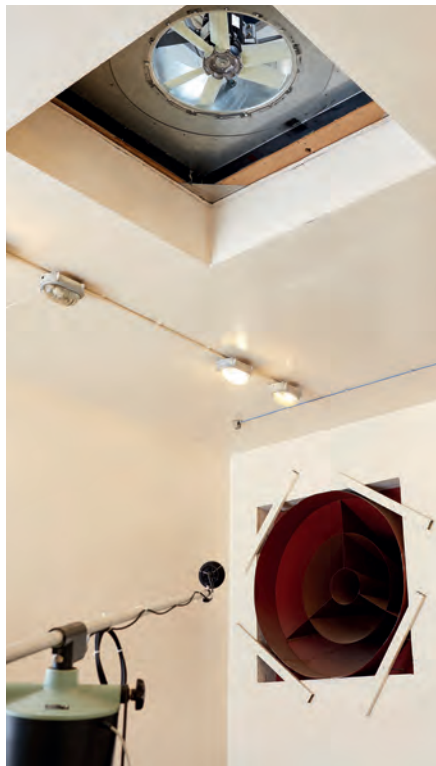

The test house has been designed to ensure that customers benefit from the best ventilation solutions in the market today. The facilities have been designed to meet the latest industry standards and carry the appropriate approvals including those from the British Standards Institute (BS) and the Air Movement and Controls Association (AMCA).

Nuaire offer two different chambers to ensure the products are tested in accordance with the suitable application; whether this be a ducted or a non-ducted application. The facilities allow Nuaire to self certify for both aerodynamics and acoustic performance.

Rigorous testing is carried out to ensure all key performance factors are attained, including air volume and pressure as well as noise, power consumption, vibration and electromagnetic compatibility.

All products are tested throughout the process, in accordance with the latest industry and regional standards for their intended market sector and application. Regular audit testing is also carried out on a frequent basis.

The entire Smoke range offering from Nuaire has been independently tested.



ACCREDITATIONS & MEMBERSHIPS

Nuairer's reputation for quality has grown through a total commitment to continuous improvement. Nuairer has worked diligently to achieve recognition for both products and facilities. Nuairer is proud to have achieved the following standards and recognition for the efforts made by the entire Nuairer team and partnerships.

QUALITY STANDARDS

- PAS99: 2012
- OHSAS 18001:2007
- ISO 9001:2015 Quality management systems - requirements.
- ISO 14000:2015 Environmental management.

TEST STANDARDS

- BS EN ISO 5801: 2017 - Fans for General Purposes - performance testing using standardised airways.
- ISO 13350 - Fans for General Purposes - performance testing of jet fans.

INFORMATION STANDARD

- ISO 13348 - Industrial fans - tolerances, methods of conversion and technical data presentation.

HIGH TEMPERATURE TEST STANDARD

- EN 12101-3: 2015 - Smoke and Heat control systems - part 3. Specification for powered smoke and heat exhaust ventilators.

ACOUSTIC TEST STANDARDS

- AMCA300:2014 Reverberant Room Method for Sound Testing of Fans.
- ISO13347:2004 Determination of fan sound power levels under standardised laboratory conditions.
- ISO 3744 - Acoustics - determination of sound power levels of noise sources using sound pressure - engineering method in an essentially free field over a reflecting plane.

BALANCE AND VIBRATION STANDARDS

- ISO 1940-1 - Safety of machinery - basic concepts, general principles for design - part 1: basic terminology and methodology.
- ISO 10816-1 - Mechanical Vibration - evaluation of machine vibration by measurement of non-rotating parts - Part 1 general guidelines.
- ISO 14694 - Industrial fans - specifications for balance quality and vibration levels.

SAFETY (DECLARATION OF EC COMPLIANCE) STANDARDS

- EN ISO 12100-1 - Safety of machinery - basic concepts, general principles for design - part 1: basic terminology, methodology.

- EN ISO12100-2 - Safety of machinery - basic concepts, general principles for design - part 2 - technical principles.
- EN60204-1 - Safety of machinery, electrical equipment of machines - part 1: general requirements.
- EN 294 - Safety of machinery - safety distances to prevent danger zones from being reached by the upper limbs.
- EN13857 - Safety machinery - safety distances to prevent danger zones being reached by upper and lower limbs.
- ISO 12499 - Industrial fans - mechanical safety of fans - guarding.

DIRECTIVES

- 2006/42/CE - Machinery Directive
- 2014/30/EU - Low Voltage Directive
- 2014/35/EU - EMC Directive
- 305/2011 - Construction products directives (CPD).
- 2009/125/EC Framework for the setting of Ecodesign requirements for energy-related products.

REGULATIONS

- EU/1253/2014 Ecodesign requirements for ventilation units.
- EU/327/2011 Ecodesign requirements for fans driven by motors.

ATEX REGULATION

- ATEX 2014/34/EU - Equipment and protective systems intended for use in potentially explosive atmospheres.

ATEX STANDARDS

- EN 14986 - Design of fans working in potentially explosive atmospheres.
- EN 13463-1 - Non-electrical equipment for use in potentially explosive atmospheres - part 1: basic method and requirements.

As well as being accredited by the relevant international bodies, Nuairer is proud to be an active member of these globally-recognised bodies, and works with them to drive up ventilation industry standards worldwide.

MEMBERS OF:

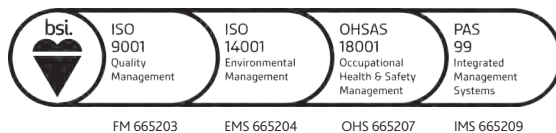



GLOBAL LOGISTICS



Nuaire is renowned for its attention to detail and has over 30 years of experience in delivering ventilation equipment from the UK to worldwide destinations. Nuaire work to ensure the highest standards demanded by the export market are met, ensuring that the shipment arrives on time and in pristine condition.

Nuaire uses a variety of expert logistical partners, covering countries and regions around the world, whilst providing a dedicated point of contact for overseas customers. This is a customer care delivery package, which has set a new standard for the ventilation industry.

All goods are expertly secured by a team of professional packers ensuring your equipment is received in perfect condition ready for installation.

The specialist export team is fully conversant with all documentation, ensuring a smooth, trouble free process from official order through to delivery on site.





OUR SERVICES

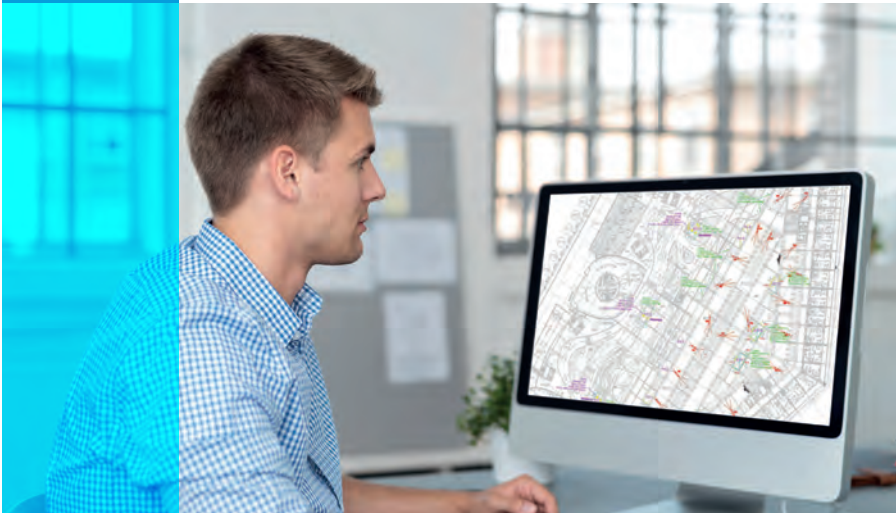

DEDICATED CUSTOMER SUPPORT

Nuaire is passionate about customer service and establishing long-term partnerships. To achieve this, there is a specialist team fully conversant with your project and application requirements ensuring you have a smooth and trouble free process.

To achieve the right commercial and economical solution for your project, Nuaire has a dedicated technical support team. The team will be there to support you in the best solution package for the application.

AXIAL CONFIGURATOR

Axial Configurator is a practical and extremely helpful tool to assist with the selection of products to meet your project requirements.

The software provides detailed datasheets comprising efficiency, performance, sounds, wiring, dimensional data and specification. The software allows all of the data to be exported to suit your needs.

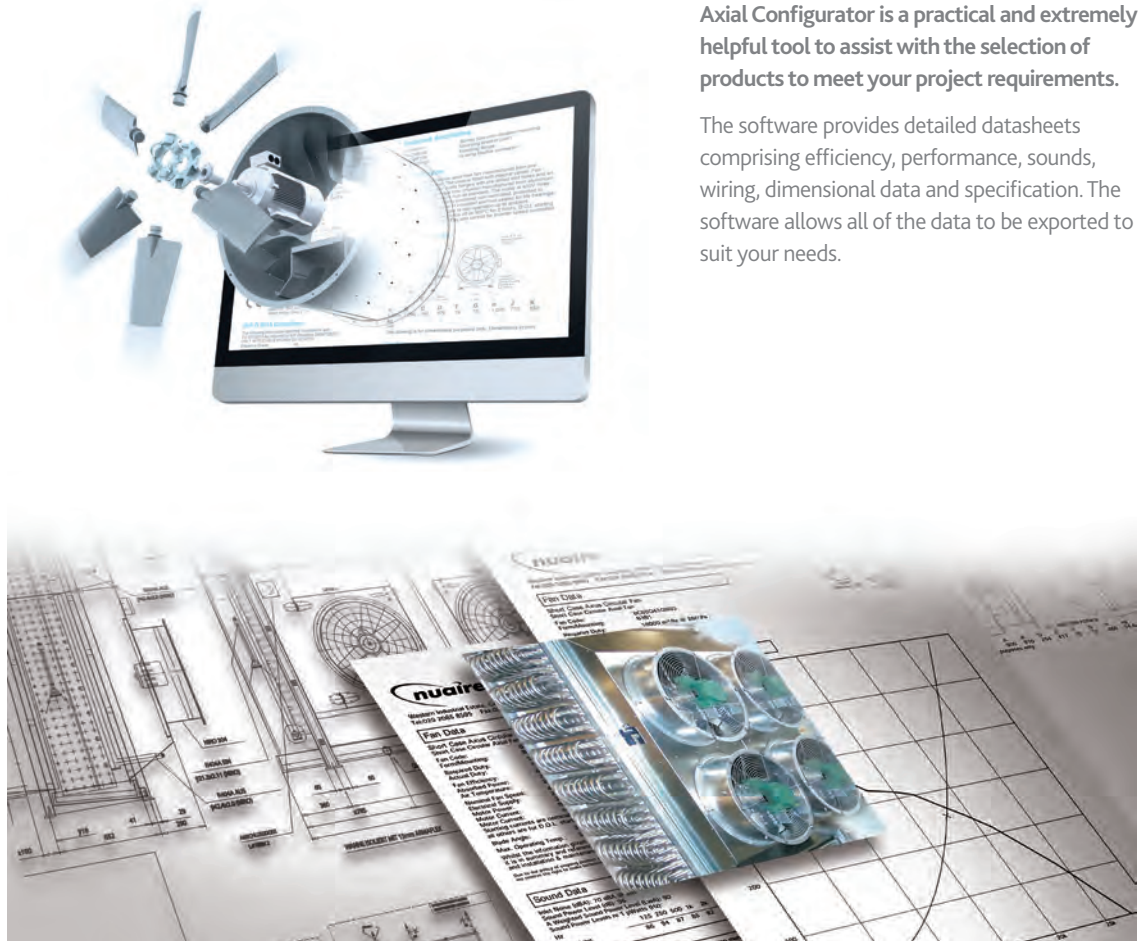

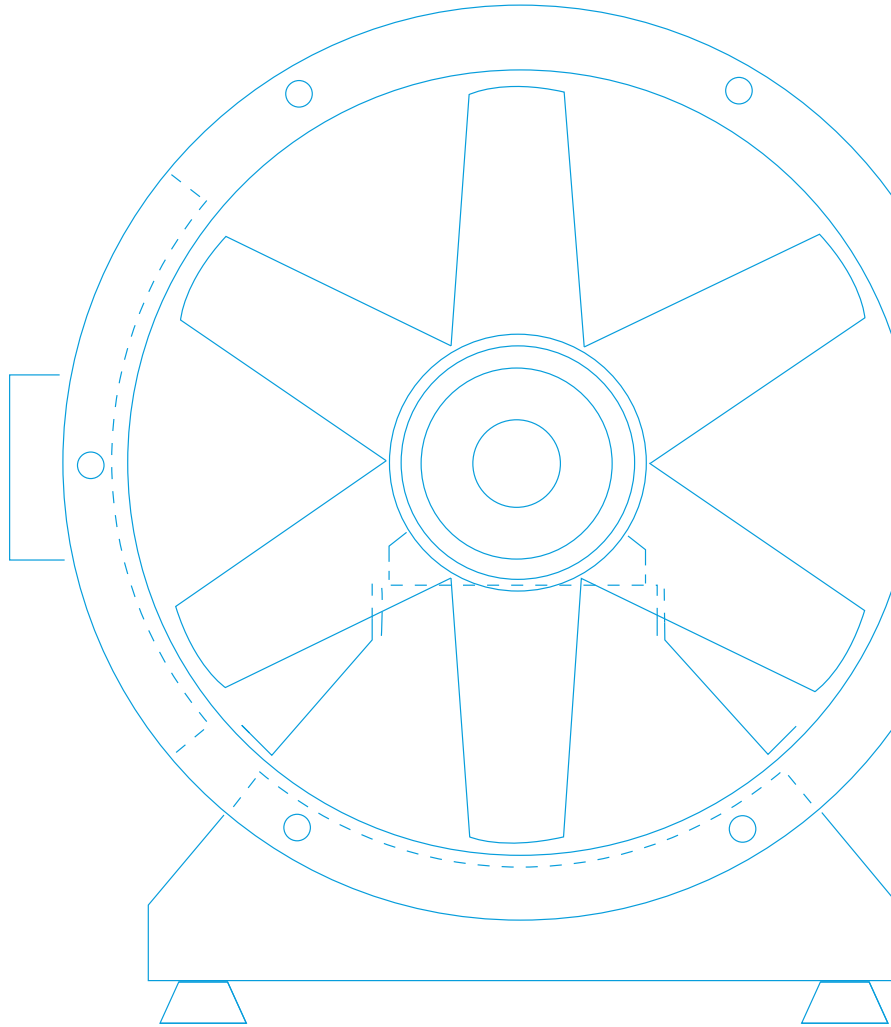

NUAIRE. FOR THE COMPLETE VENTILATION SOLUTION

T +44(0)29 2085 8484 E INTERNATIONAL@NUAIRE.CO.UK W NUAIREGROUP.COM @NUAIREGROUP



August 2018.